

*Teaching Tip*  
**A Teaching Module of Database-Centric Online  
Analytical Process for MBA Business Analytics  
Programs**

Shouhong Wang and Hai Wang

Recommended Citation: Wang, S. & Wang, H. (2019). Teaching Tip: A Teaching Module of Database-Centric Online Analytical Process for MBA Business Analytics Programs. *Journal of Information Systems Education*, 30(1), 19-26.

Article Link: <http://jise.org/Volume30/n1/JISEv30n1p19.html>

Initial Submission: 4 January 2018  
Accepted: 26 June 2018  
Abstract Posted Online: 4 December 2018  
Published: 13 March 2019

Full terms and conditions of access and use, archived papers, submission instructions, a search tool, and much more can be found on the JISE website: <http://jise.org>

ISSN: 2574-3872 (Online) 1055-3096 (Print)

---

## **Teaching Tip**

# **A Teaching Module of Database-Centric Online Analytical Process for MBA Business Analytics Programs**

**Shouhong Wang**  
Charlton College of Business  
University of Massachusetts – Dartmouth  
Dartmouth, MA 02747, USA  
swang@umassd.edu

**Hai Wang**  
Sobey School of Business  
Saint Mary's University  
Halifax, NS B3H 2W3, Canada  
hwang@smu.ca

### **ABSTRACT**

Business schools are increasingly establishing MBA business analytics programs. This article discusses the importance of a sufficient body of knowledge about databases for MBA business analytics students. It presents the pedagogical design and the teaching method of a module of database-centric OLAP (online analytical process) for an MBA business analytics course when a standalone database course is infeasible for the MBA business analytics program. The teaching module includes key database concepts for business analytics, a tutorial on database-centric OLAP, and a database-centric OLAP exercise assignment. The teaching module demands about a half-credit-hour workload and can be embedded in a three-credit-hour MBA business analytics course.

**Keywords:** Big data, Business intelligence, Business analytics, Curriculum design & development, Data management, Northwind database

### **1. INTRODUCTION**

The information systems (IS) education area is developing new IS courses and new IS programs to meet the needs of the job market (Topi et al., 2010; Mills, Chudoba, and Olsen, 2016). In light of a profound impact of the Big Data wave on all types of organizations (Beyer and Laney, 2012; Einav and Levin, 2014; Wolff, 2014), many IS faculties have taken the lead to develop new programs or new courses related to Big Data for MBA students. Business analytics (BA) is one of the emerging topics in the context of Big Data (Phillips-Wren et al., 2015). BA programs at the MBA level are growing quickly in business schools during the recent past (Kowarski, 2017). In its broadest definition, BA is a conceptual framework of practices for continuous iterative exploration and investigation of past business performance to gain insight and to drive business planning (Bartlett, 2013). Commonly, business analytics, business intelligence, and business intelligence and analytics are interchangeable terms. Given the breadth of the subject, there are many approaches to teaching of MBA BA programs.

Due to the restricted number of courses in an MBA program and other factors, few MBA BA programs offer a standalone database course, although the topic is an important part of business Big Data. On the other hand, the majority of students do not have sufficient knowledge about databases before starting their MBA BA programs. Hence, an instructional improvement must be considered to include a teaching module of database-centric BA for MBA BA programs.

This article provides tips for designing and teaching a module of database-centric OLAP (online analytical process) which can be integrated into an MBA BA course. The rest of the article is organized as follows. Section 2 is an overview of the database-centric OLAP module. Section 3 offers teaching suggestions. Section 4 presents evidence of success. Section 5 discusses thoughts shared with MBA students when teaching the database-centric OLAP module. Finally, Section 6 reflects upon how this article contributes to information systems education.

## 2. THE STRUCTURE OF THE TEACHING MODULE OF DATABASE-CENTRIC OLAP

The teaching module of database-centric OLAP teaches how one can use databases professionally for BA, but does not teach database design or database construction. The teaching module delivers the following essential concepts of database-centric OLAP for MBA BA students.

### 2.1 Basics of Databases for MBA BA Students

**2.1.1 Basic terminology of relational databases.** The teaching module introduces important terms commonly used in the database area and the concepts related to these terms. It highlights key issues of data resources management that are associated with the necessity of databases in organizations: data redundancy control and data integrity assurance. It explains that a data model describes the structure of data, and the relational data model is the one used in all business databases with few exceptions, although there are other types of data models. The teaching module uses examples to explain the following terms and related concepts: *relational data model*, *relational database management system*, *entity*, *table (or relation)*, *attribute*, *primary key*, *relationship*, and *foreign key*.

**2.1.2 Entity-relationship diagrams.** A one-to-many (1:m) relationship between two entities is an important concept for BA because it is used for data cube generation in OLAP. The teaching module uses examples to explain the meaning of 1:m relationships in relational databases. It also points out that there is no way to represent a many-to-many (m:m) relationship directly in relational databases, and any m:m relationship between two entities must be converted into two 1:m (or 1:1 which is a special case of 1:m) relationships during the database design. The teaching module mentions the concept of normalization briefly but does not give any detailed discussion on database design and normalization.

Using a simple example (see Figure 1), the teaching module introduces ER (entity-relationship) diagrams and emphasizes that MBA BA students should be able to read ER diagrams because an ER diagram is the blueprint of a database and can help users navigate the entire database when extracting needed data sets for BA.

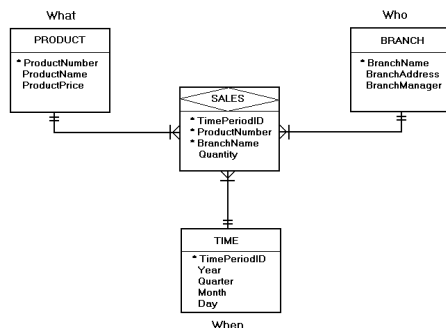

Figure 1. ER Diagram Example

The teaching module then presents the database implemented in Microsoft Access in accordance with the ER diagram of the example and demonstrates how one can navigate the database through visualizing the implemented entity-

relationships inside the database (see Figure 2) to extract needed data sets from the database for BA.

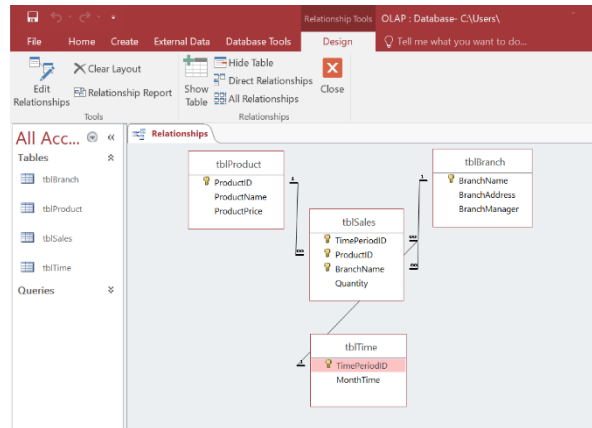

Figure 2. Visualization of the Implemented Database

**2.1.3 Query formulation.** After the introduction, the teaching module explains that the standard SQL (Structured Query Language) is supported by any relational database management system so that users of the database are able to retrieve needed information by using SQL statements. For MBA BA students, SQL programming skills are not required because commonly used database management systems and BA tools provide QBE (query-by-example), a graphical query tool, to allow users to retrieve information through visualized commands. QBE generates SQL for the user, is easy to use, and provides sufficient functionalities for ordinary BA. This teaching module teaches MBA BA students to use QBE for BA practices.

### 2.2 Overview of OLAP

While the IT industry and the academic world are inventing new technologies for Big Data, traditional techniques of BA, such as OLAP, are still the major tools for business organizations to dealing with structured data (Howson, 2012; SoftwareAdvice, 2018). Since the data sources used for OLAP are relational databases, OLAP is a perfect topic for MBA BA students to understand why knowledge about databases is crucial for BA. The teaching module introduces terminology used in the OLAP area, explains technical details of OLAP, and requires MBA BA students to conduct a database-centric OLAP exercise to understand the role of databases in BA. The database-centric OLAP process includes a navigation of the database, BA strategy development, queries, data cube generation and operations, statistical analysis, and data visualization. The teaching module not only lays a foundation for students to learn OLAP, but also helps students develop a better understanding of the strategy-driven and iterative nature of the BA process in general.

**2.2.1 OLAP framework.** The OLAP section starts with a framework of a strategy-driven BA process. A key point of this part is that database use and any BA methods including OLAP do not generate meaningful knowledge automatically, and BA professionals must possess a priori knowledge of the business context and set pertinent objectives of the analytical process to obtain meaningful BA results (Olszak and Ziemia, 2012). The framework of OLAP describes the aspects of OLAP strategy

formulation, data selection, and general steps of a trial-and-error process as illustrated in Figure 3.

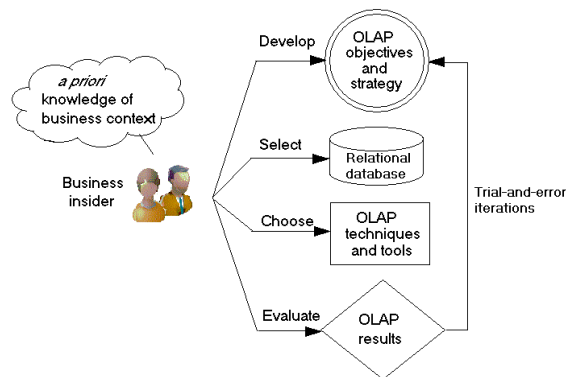

Figure 3. Framework of a Database-Centric Online Analytical Process

**2.2.2 Multidimensional data and data cubes.** To explain the role of relational databases in OLAP, multidimensional data are explained. Illustrative examples are used to introduce the concept of data cubes along with ER diagrams of fact tables, star schemas, and snowflake designs. These examples demonstrate how a relational database can represent the concerned facts that are related to various aspects (or dimensions) such as what, who, where, how, when, and why. The teaching module stresses that a star schema or a snowflake design is the key to generating meaningful multidimensional data cubes for OLAP.

**2.2.3 Four fundamental techniques used in OLAP.** Four fundamental techniques used in OLAP are discussed in detail – query, data cube operations (slicing, dicing, and drill-down), statistical analysis, and data visualization. The primary feature of OLAP is the use of data cube operations (slicing, dicing, and drill-down) to process multidimensional data to find interesting information from complicated data sets. A data cube operation is often joined by queries, statistical analyses (e.g., regression, t-test, ANOVA), or data visualization to support OLAP for BA.

### 3. TEACHING SUGGESTIONS

The teaching module expects about a half-credit-hour workload and can be embedded in a three-credit-hour MBA course. Currently, this teaching module is embedded in an introductory business intelligence and knowledge management course which is a required course in the MBA BA program of one of the authors' institutions.

#### 3.1 To Clarify Why MBA BA Students Need to Know about Databases

Business data could be structured and unstructured, and analyses of structured data are the major activities of BA. Few MBA candidates without taking this teaching module fully understand that business organizations should manage structured data by using databases instead of other tools such as spreadsheets (e.g., Excel). The first suggestion for teaching the database module is to emphasize why databases must be used for enterprises to address three common problems in data

resources management: uncontrolled redundant data, violation of data integrity, and relying on human memory to search needed data.

Nowadays, students learn much from the Internet. Ironically, most of the sample data sets available on the Internet for BA exercises are single-table data (or “flat” datasheets), but few sample data sets in the form of a database can be found on the Internet. When a “flat” datasheet is extracted from the original database, the data has been pre-processed by the data-maker to make the data set easy to disseminate on the Internet and convenient for the users (especially those who know nothing about databases). Obviously, a “flat” datasheet extracted from a database has already encompassed the data-maker’s interest, assumptions, as well as possible mistakes. When using a “flat” datasheet for a BA practice, the user skips the first and critical step of BA: selection of relevant data from the database(s) to implement their own BA strategies for the organization. Figure 4 illustrates defective BA practices with “flat” datasheets.

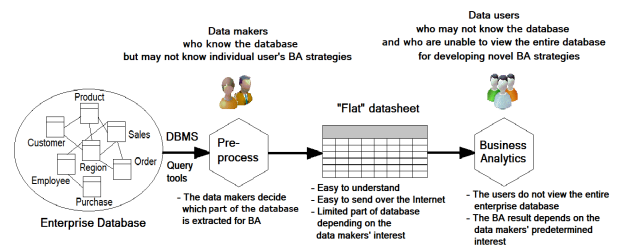

Figure 4. Defective BA Practices with “Flat” Datasheets

#### 3.2 To Develop Teaching Materials

As no suitable teaching material for the teaching module can be found on the market of textbooks, a teaching note has been developed. The teaching note has companion materials including a tutorial on database-centric OLAP, videos of lectures, and artifacts for an OLAP assignment. The teaching note and all companion materials are available online for students on the course site in the university’s learning management system and can be obtained from the authors upon request.

The tutorial on database-centric OLAP includes a step-by-step OLAP hands-on example. The environment used for OLAP is Microsoft Access and Microsoft Excel because the Microsoft Office environment is commonly available and provides seamless connections between an Access database and BA analytical tools in Excel. The tutorial explains that Excel is an excellent OLAP tool, and multidimensional data stored in a database can be imported into Excel and used in the creation of a pivot table for OLAP purposes. The tutorial provides a tiny Access database with hypothetical sample data. The database has four tables: one fact table (Sales) and three dimensional tables (Product, Location, and Time). A query of the database generates a data cube based on the four tables. The data cube is imported into Excel and is converted into a pivot table for OLAP. The tutorial demonstrates step-by-step processes of applications of the four OLAP techniques (i.e., query, slicing/dicing, statistical analysis, and data visualization) in Excel. Several lecture video clips accompany the teaching note. The Access and Excel artifacts are available for students to download from the course site. Students are able to follow the

tutorial to exercise database-centric OLAP until they fully understand database manipulation and the four fundamental OLAP techniques in the Microsoft Office environment.

The rest of this sub-section presents selected illustrative descriptions supported by figures to provide more details about the teaching note. Figure 5 depicts the Microsoft Office environment of database-centric OLAP.

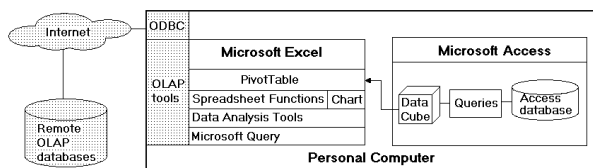

Figure 5. The Computational Environment Used in the Teaching Module

Figure 6 demonstrates a simple example to explain the process from query to analytics that generates a finding: “East Branch was the number one Laptop sales manager in both Mar and Apr, although other branches (West and Central) had the same sales levels in one of the two months.”

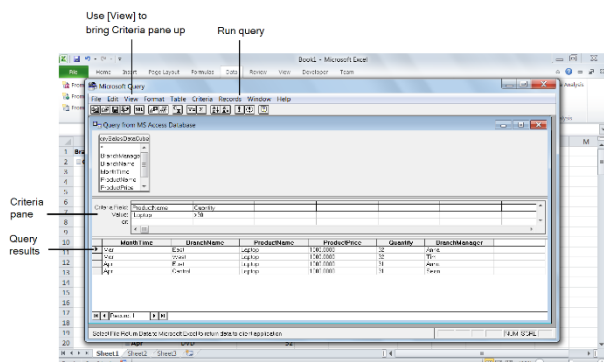

Figure 6. An Example of Process from Query to Analytics

Figure 7 demonstrates a simple example to explain the process from the slicing/dicing/drill-down process to analytics that generates a finding: “East Branch has a significant increase of sales of DVD in April compared with March by  $((73-57)/57=28\%)$ .”

Figure 8 demonstrates a simple example to explain the process from statistical analysis (t-test) to analytics that generates a finding: “The difference of sales between West Branch and South Branch is insignificant, although the average sales of West Branch is slightly higher than sales of South Branch (by  $(30.5-29)/29=5\%$ .”

Figure 9 demonstrates a simple example to explain the process from statistical analysis to analytics that generates a finding: “Over the time period, the fluctuation sales patterns of DVD and PDA are similar, while the sales of other three products are increasing after March.”

The teaching module was offered in both face-to-face and online settings using the same set of teaching materials. Flipped classrooms were used in the face-to-face setting; that is, students were required to learn online materials before the class and to be engaged in discussions and knowledge sharing in the classroom with the guidance of the instructor.

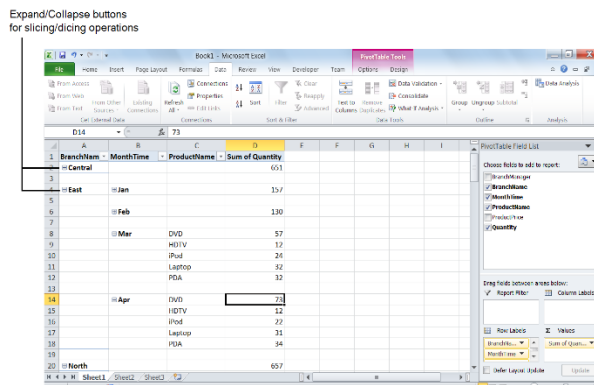

Figure 7. An Example of Process from Slicing/Dicing/Drill-Down to Analytics

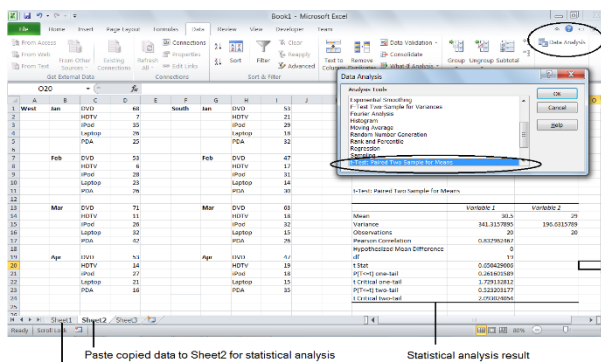

Figure 8. An Example of Process from Statistical Analysis to Analytics

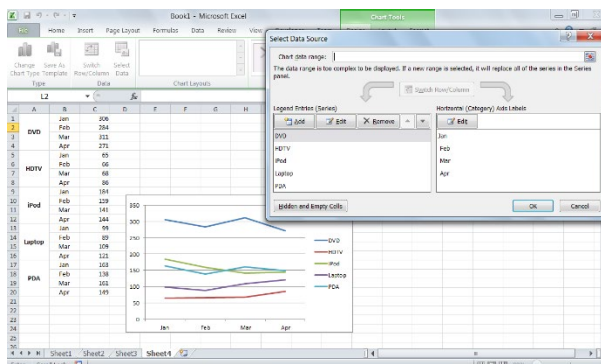

Figure 9. An Example of Process from Data Visualization to Analytics

### 3.3 To Avoid Common Mistakes in OLAP

If a data analyst does not fully understand the concept of relational databases and data cubes, he/she might use flawed data sets for OLAP. To obtain meaningful OLAP results based on a good data cube design, the data analyst needs to identify 1:m chains towards the fact table. The 1:m chains could come from many dimensions towards the fact table, but no backwards 1:m link is allowed (see Figure 10) because the table on the m-side of the backward link is not an aspect dimension of the fact table. As Excel is so error tolerant, it can convert any data set into a pivot table even though the entire data set is not a

meaningful data cube. For example, one can input tables with mixed forwards and backwards 1:m links into Excel and obtain a pivot table that actually mixes more than one data cube. More generally, many BA tools on the software market do not provide sufficient measures to prevent the use of fake data cubes.

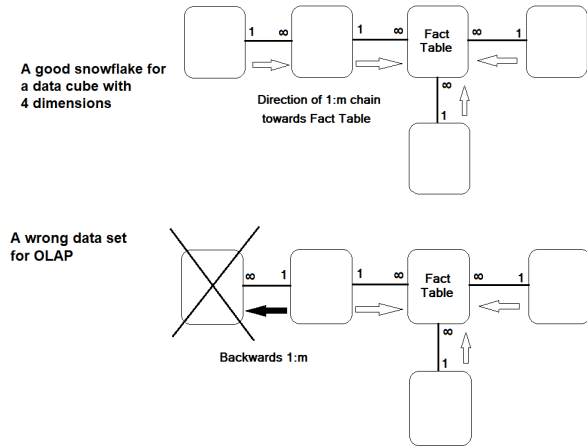

Figure 10. Good Data Cube and Wrong Data Set for OLAP

### 3.4 To Teach Practical BA Skills

The final part of the teaching module is an OLAP assignment that requires each student to apply the learned knowledge to OLAP. Given the fact that no sample database for BA can be found on the Internet although countless flat datasheets are available for free, this OLAP assignment uses Northwind, a sample database of a hypothetical trading company provided by Microsoft Access. Northwind has 18 tables and is adequate for the MBA BA exercise assignment.

The OLAP assignment requires students to articulate their strategies of OLAP, to generate at least two data cubes in Access, to import the data cubes into Excel to obtain pivot tables, and to apply the four fundamental OLAP techniques in Excel to derive BA results with at least five interesting findings. Table 1 exhibits the assessment rubrics of the assignment.

The assignment requires each student to document the database-centric OLAP exercise. The assignment is followed by an OLAP competition session to allow students to share their novel OLAP strategies and interesting BA findings. Even though the database is small, the OLAP results were quite diverse since students created their own OLAP strategies based on different data sets.

	<b>4. Exemplary</b>	<b>3. Good</b>	<b>2. Fair</b>	<b>1. Poor</b>
<b>OLAP Strategy and Findings (20%)</b>	<ul style="list-style-type: none"> <li>◦ The strategy has very strong managerial sense</li> <li>◦ Very useful for management practices</li> <li>◦ At least 5 interesting findings</li> </ul>	<ul style="list-style-type: none"> <li>◦ The strategy has strong managerial sense</li> <li>◦ Useful for management practices</li> <li>◦ At least 4 interesting findings</li> </ul>	<ul style="list-style-type: none"> <li>◦ Weak managerial sense</li> <li>◦ Weak for management practices</li> <li>◦ A few interesting findings</li> </ul>	<ul style="list-style-type: none"> <li>◦ Lack of managerial sense</li> <li>◦ Little value for management practices</li> <li>◦ Lack of interesting findings</li> </ul>
<b>OLAP Techniques (50%)</b>	<ul style="list-style-type: none"> <li>◦ Full understanding of OLAP</li> <li>◦ Excellent applications of all four (4) OLAP techniques</li> <li>◦ Extensive use of diversified data resources</li> </ul>	<ul style="list-style-type: none"> <li>◦ Good understanding of OLAP</li> <li>◦ The applications covers all four OLAP techniques</li> <li>◦ Good use of the data resources</li> </ul>	<ul style="list-style-type: none"> <li>◦ Weak understanding of OLAP</li> <li>◦ Some OLAP techniques are missing</li> <li>◦ The data resources used for OLAP are narrow</li> </ul>	<ul style="list-style-type: none"> <li>◦ Mis-understanding of OLAP</li> <li>◦ Only simple OLAP techniques are used</li> <li>◦ Only a few tables are used for OLAP</li> </ul>
<b>Organizational Structure (15%)</b>	<ul style="list-style-type: none"> <li>◦ Important details and topics are well organized</li> <li>◦ Clearly developed and linked introduction and conclusion</li> <li>◦ Very good transitions</li> </ul>	<ul style="list-style-type: none"> <li>◦ Generally well organized, fairly concise</li> <li>◦ Fairly clear introduction and conclusion</li> <li>◦ Section headings are unclear</li> </ul>	<ul style="list-style-type: none"> <li>◦ Inadequate section formation.</li> <li>◦ Unclear introduction and conclusion</li> <li>◦ Unclear transitions</li> </ul>	<ul style="list-style-type: none"> <li>◦ Rambling introduction and conclusion</li> <li>◦ No flow or transitions between paragraphs</li> <li>◦ Did not use section headings</li> </ul>
<b>Writing and Presentation (15%)</b>	<ul style="list-style-type: none"> <li>◦ Excellent screenshots and explanations of OLAP</li> <li>◦ Appropriate use of vocabulary</li> <li>◦ Professional page/slides layout</li> </ul>	<ul style="list-style-type: none"> <li>◦ Good screenshots and explanation of OLAP</li> <li>◦ Moderate use of vocabulary or limited misuse of vocabulary</li> <li>◦ Minor problems with page/slides layout</li> </ul>	<ul style="list-style-type: none"> <li>◦ Noticeable missing details</li> <li>◦ Limited use or moderate misuse of vocabulary</li> <li>◦ Significant problems with page/slides layout</li> </ul>	<ul style="list-style-type: none"> <li>◦ Many errors and missing items</li> <li>◦ Poor vocabulary or annoying misuse of vocabulary</li> <li>◦ Annoying page/slides layout</li> </ul>

Table 1. Assessment Rubrics for the Learning Outcomes

**3.5 To Clarify Why MBA BA Students Need to Know about Database-Centric OLAP**

Many MBA students might have a common question: “Why do we (BA professionals) have to learn OLAP? ERP systems have dashboards for business intelligence already.” The teaching module encourages students to learn about examples of dashboards of ERP systems to understand the nature of dashboards. Dashboards in ERP systems can automate BA processes for cases when an OLAP strategy has been developed and a related OLAP analysis has been found useful so that people want to apply the OLAP analysis repeatedly and frequently. The advantages of using routine OLAP analyses are simplicity, convenience, and speed. However, relying on routinized OLAP analyses through dashboards without understanding the database and OLAP techniques behind those dashboards could make people less innovative and less capable of tackling new business problems. A novel OLAP analysis beyond what the dashboard has already automated could make a significant difference for the organization. This teaching module helps MBA BA students understand the “black-boxes” behind those dashboards in ERP systems and develop analytical skills for BA.

**4. EVIDENCE**

The teaching module has been offered regularly in either face-to-face or online forms during the past five years. The assessment instrument used in this teaching module was the OLAP exercise assignment. All MBA students who took this teaching module and completed the database-centric OLAP exercise assignment have demonstrated their understanding of the key concepts of database for BA. Table 2 exhibits the learning objectives of this teaching module and the evidence of students’ learning outcomes based on the assessment of assignments of 72 students who have completed this teaching module.

Learning Objectives	Student’s Learning Outcomes (Scores *)
Be able to formulate OLAP Strategy given a database	Range: 75% -100% Average: 84.3%
Be able to generate at least two (2) meaningful data cubes for OLAP	Range: 70% - 100% Average: 87.5%
Be able to apply four (4) OLAP techniques	Range: 75% - 100% Average: 93.5%
Be able to discover at least five (5) interesting findings	Range: 80% - 100% Average: 96.8%
Be able to disseminate OLAP results by using effective presentations (e.g., PowerPoint presentations with annotated screenshots)	Range: 70% - 100% Average: 81.6%
Be able to document OLAP as a business analytics process	Range: 80% - 100% Average: 92.6%

\* The passing score of this teaching module was set to 65%.

**Table 2. Evidence of Students’ Learning Outcomes**

At the end of the teaching module, students were asked to complete a short questionnaire anonymously. Table 3 summarizes the responses from 67 students.

Questions	Percentage of Students Selecting Agree or Strongly Agree
The concept of database is important for MBA BA students	100%
You feel you did not possess sufficient knowledge about databases for BA before taking this teaching module, and you need this teaching module for your MBA BA study	91%
The teaching module of database-centric OLAP for BA enhances MBA BA students’ knowledge set, skill set, and integrated thinking ability	95%
The database-centric OLAP techniques introduced in this teaching module are not difficult to learn	84%
The workload for 0.5-credit-hours for this teaching module is appropriate for the MBA BA program	85%
The delivered teaching module of database-centric OLAP meets your expectation of your MBA BA study	87%

**Table 3. Summary of Students’ Feedback**

Informal comments from MBA BA students have indicated their positive learning experiences. The following excerpts of students’ informal comments have proved the value of this teaching module.

- The OLAP assignments were rewarding and relevant to the material. I really enjoyed the class. I believe that it will aid me in my professional work in the future.
- The OLAP assignments are tough; however, students will gain so much knowledge and real life-related experiences after finishing this course.
- I took a database course years ago, and know SQL. Now I have learned how to capitalize SQL for business analytics.

The above summary of evidence was based on limited observations. The opinion-based information collected by the authors may involve biases threatening any generalization. As

no comparative teaching methods of database-centric BA are available for MBA BA programs at this point, further assessment of the teaching module has not been conducted. Potential subjects for future investigations include more analyses of the design of the materials and additional assessments of learning outcomes.

## 5. DISCUSSION

BA has been one of the major streams of research and education of Big Data in the business field (Chen, Chiang, and Storey, 2012). However, Big Data is not limited to the business sector. In fact, many other sectors, such as medicine and healthcare, bio-informatics, government, military, global economy, environment, astronomy, global social system, homeland security, cybersecurity, weather, etc., are all facing the Big Data problem. The Federal Big Data Commission (TechAmerica, 2012) presented ten typical Big Data projects; however, none of these Big Data projects came from the private business sector. There is no question that the private business sector is facing the Big Data problem; nevertheless, the overall magnitude of Big Data in business organizations is not as big as that in many other sectors. In fact, informative data for a particular business organization are usually not really big in comparison with non-business Big Data in many other sectors. First, the scope of decision making or planning within a business organization can never go beyond the boundary of the organization. When a business organization uses Big Data for decision making and/or business planning, the scale of Big Data is rather small in comparison with, for example, global economy and governments. Second, business data is time sensitive. The old data of a business organization are unlikely to be of much relevance to dynamic decision-making or business planning of the organization. Compared with, for example, astronomy, business organizations typically use up-to-date data for BA. Third, Big Data used for business are typically structured, although unstructured data, such as in social media marketing and customer service, could be involved. Compared with, for example, homeland security, business organizations typically deal with much less heterogeneous Big Data. Hence, the insightful meaning of Big Data to business can be still debatable in the BA area.

The research community of Big Data proclaims that traditional relational database management systems and traditional statistics tools often have difficulties to handle Big Data (Purdue, 2012). However, after a decade of Big Data, while managerial BA textbooks and BA case studies introduce buzzwords of innovative Big Data technologies without deep insights, technical BA textbooks still put emphasis on traditional statistical theories and applications. The major tools on the software market used for BA in ordinary business organizations still depend on relational database management systems instead of NoSQL databases (Asamoah et al. 2016). Hadoop technologies have been widely used to store Big Data, but they have not changed the fundamental relational data model and conventional BA approaches.

Currently, there is no commonly accepted model curriculum for MBA BA programs. Realistically, the body of knowledge concerning databases is certainly important to MBA BA students to meet the challenge of BA in the business field (Carillo, 2017; Sun, Strang, and Firmin, 2017). Given the fact

that a standalone database course is infeasible for many MBA BA programs and advanced database topics are not particularly relevant to BA, a teaching module of database-centric OLAP integrated in a BA course would meet the needs of MBA BA students to acquire sufficient database knowledge for their BA careers. The evidence presented in this article supports the practice.

## 6. CONCLUSIONS

Databases are an important component of BA. However, the majority of MBA BA programs do not require prerequisites related to databases and do not include a standalone database course in their curricula. To address this concern, a teaching module of database-centric OLAP has been designed and implemented in our MBA BA program. The teaching module explains why and what MBA BA students need to know about databases, and it provides a tutorial on database-centric OLAP. The teaching module expects about a half-credit-hour workload and can be embedded in a three-credit-hour MBA course.

This teaching tip describes the structure of the teaching module of database-centric OLAP for MBA BA programs. Students' performance and evaluations have indicated their positive learning experiences and overall satisfaction with the teaching module. By exercising the database-centric OLAP assignment, students had no difficulty in learning the basics of databases for BA within a short timeframe. The progressive nature of the teaching module accommodates different levels of preparation for learning databases and sets the stage for students to progress to advanced levels on their own. The design and delivery of the teaching module have demonstrated that a body of knowledge about database-centric BA is practicable and useful for MBA BA students. The teaching tip could be valuable for IS instructors who wish to incorporate a practical teaching module of database-centric OLAP in their MBA BA courses.

## 7. ACKNOWLEDGEMENTS

The comments of the Editor, the Associate Editor, and six anonymous reviewers have contributed significantly to the revisions of the paper.

## 8. REFERENCES

- Asamoah, D. A., Sharda, R., Kalgotra, P., & Ott, M. (2016). Who Renews? Who Leaves? Identifying Customer Churn in a Telecom Company using Big Data Techniques. *Journal of Information Systems Education*, 27(4), 223-232.
- Bartlett, R. (2013). *A Practitioner's Guide to Business Analytics: Using Data Analysis Tools to Improve Your Organization's Decision Making and Strategy*. New York, NY: McGraw-Hill.
- Beyer, M. A. & Laney, D. (2012). The Importance of "Big Data": A Definition. *Gartner*. Retrieved July 4, 2018, from <https://www.gartner.com/doc/2057415/importance-big-data-definition>.
- Carillo, K. D. A. (2017). Let's Stop Trying to be "Sexy" – Preparing Managers for the (Big) Data-Driven Business Era. *Business Process Management Journal*, 23(3), 598-622.



- Chen, H., Chiang, R., & Storey, V. C. (2012). Business Intelligence and Analytics: From Big Data to Big Impact. *MIS Quarterly*, 36(4), 1166-1188.
- Einav, L. & Levin, J. (2014). The Data Revolution and Economic Analysis. *The National Bureau of Economic Research*. Retrieved July 4, 2018, from <http://web.stanford.edu/~jdlevin/Papers/BigData.pdf>.
- Howson, C. (2012). The Business Intelligence Market. Retrieved July 4, 2018, from <http://www.biscorecard.com/folderfd/bimarket.pdf>.
- Kowarski, I. (2017). Dive into Data with a Master's in Business Analytics. *U.S. News Education*. Retrieved July 4, 2018, from <https://www.usnews.com/education/best-graduate-schools/top-business-schools/articles/2017-02-06/consider-masters-programs-in-business-analytics>.
- Mills, R., Chudoba, K., & Olsen, D. (2016). IS Programs Responding to Industry Demands for Data Scientists: A Comparison between 2011-2016. *Journal of Information Systems Education*, 27(2), 131-140.
- Olszak, C. M. & Ziemba, E. (2012). Critical Success Factors for Implementing Business Intelligence Systems in Small and Medium Enterprises on the Example of Upper Silesia, Poland. *Interdisciplinary Journal of Information, Knowledge, and Management*, 7, 129-150.
- Phillips-Wren, G., Kulkarni, U., Iyer, L. S., & Arlyachandra, T. (2015). Business Analytics in the Context of Big Data: A Roadmap for Research. *Communications of the Association for Information Systems*, 37, 448-472.
- Purdue (2012). Challenges and Opportunities with Big Data. Retrieved July 4, 2018, from <https://www.purdue.edu/discoverypark/cyber/assets/pdfs/BigDataWhitePaper.pdf>.
- SoftwareAdvice, Buyer's Guide. Retrieved July 4, 2018, from <https://www.softwareadvice.com/bi/olap-comparison/#buyers-guide>.
- Sun, Z., Strang, K., & Firmin, S. (2017). Business Analytics-Based Enterprise Information Systems. *The Journal of Computer Information Systems*, 57(2), 169-178.
- TechAmerica (2012). Demystifying Big Data: A Practical Guide to Transforming the Business of Government. *TechAmerica Foundation: Federal Big Data Commission*. Retrieved July 4, 2018, from <https://www-304.ibm.com/industries/publicsector/fileserve?contentid=239170>.
- Topi, H., Valacich, J. S., Wright, R. T., Kaiser, K., Nunamaker, J. F. Jr., Sipior, J. C., & de Vreede, G. (2010). IS 2010: Curriculum Guidelines for Undergraduate Degree Programs in Information Systems, *Communications of the Association for Information Systems*, 26, Article 18.
- Wolff, J. G. (2014). Big Data and the SP Theory of Intelligence, *IEEE Access*, 2, 301-315.

## AUTHOR BIOGRAPHIES

**Shouhong Wang** is a Professor of Management Information Systems at the University of Massachusetts – Dartmouth. He received his Ph.D. in Information Systems from McMaster University. His teaching and research interests include innovative teaching, business intelligence, semantic networks, and knowledge management. He has published over 130 papers in academic journals and several books in the MIS area.



**Hai Wang** is a Professor in the Department of Finance, Information Systems, and Management Science at the Sobey School of Business of Saint Mary's University. He received his B.Sc. (1995) in Computer Science from the University of New Brunswick and his M.Sc. (1997) and Ph.D. (2004) in Computer Science from the University of Toronto. His research interests are in the areas of data mining, database management, knowledge management, and e-commerce. Dr. Wang has published more than 80 research articles.



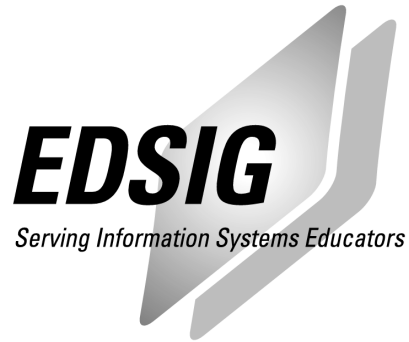

### **STATEMENT OF PEER REVIEW INTEGRITY**

All papers published in the Journal of Information Systems Education have undergone rigorous peer review. This includes an initial editor screening and double-blind refereeing by three or more expert referees.

Copyright ©2019 by the Information Systems & Computing Academic Professionals, Inc. (ISCAP). Permission to make digital or hard copies of all or part of this journal for personal or classroom use is granted without fee provided that copies are not made or distributed for profit or commercial use. All copies must bear this notice and full citation. Permission from the Editor is required to post to servers, redistribute to lists, or utilize in a for-profit or commercial use. Permission requests should be sent to the Editor-in-Chief, Journal of Information Systems Education, [editor@jise.org](mailto:editor@jise.org).

ISSN 2574-3872